

# LM1036

## Dual DC Operated Tone/Volume/Balance Circuit

### General Description

The LM1036 is a DC controlled tone (bass/treble), volume and balance circuit for stereo applications in car radio, TV and audio systems. An additional control input allows loudness compensation to be simply effected.

Four control inputs provide control of the bass, treble, balance and volume functions through application of DC voltages from a remote control system or, alternatively, from four potentiometers which may be biased from a zener regulated supply provided on the circuit.

Each tone response is defined by a single capacitor chosen to give the desired characteristic.

### Features

- Wide supply voltage range, 9V to 16V
- Large volume control range, 75 dB typical
- Tone control,  $\pm 15$  dB typical
- Channel separation, 75 dB typical
- Low distortion, 0.06% typical for an input level of 0.3 Vrms
- High signal to noise, 80 dB typical for an input level of 0.3 Vrms
- Few external components required

### Block and Connection Diagram

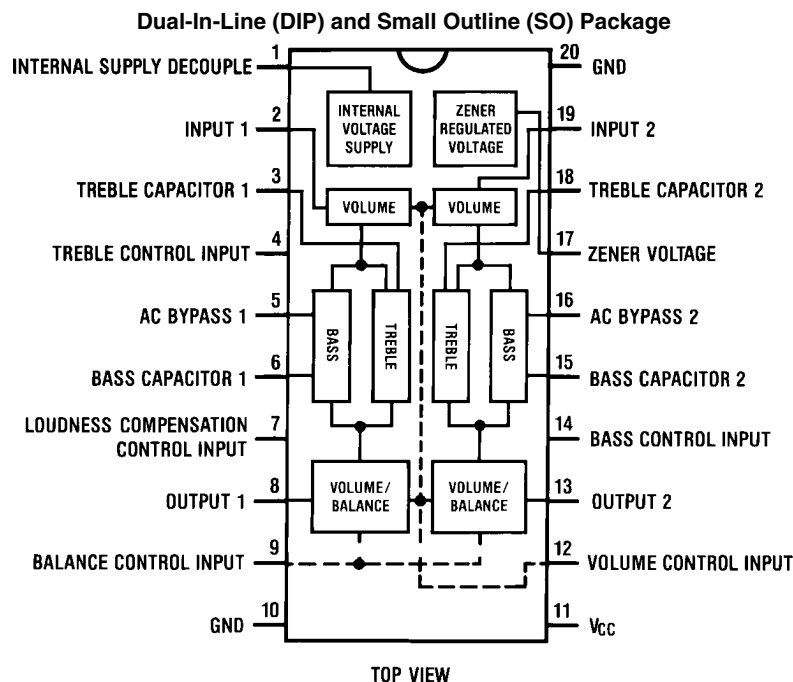

Order Number LM1036N, LM1036M or LM1036MX  
See NS Package Number N20A or M20B

514201

**Absolute Maximum Ratings** (Note 1)

If Military/Aerospace specified devices are required, please contact the National Semiconductor Sales Office/Distributors for availability and specifications.

Supply Voltage	16V
Control Pin Voltage (Pins 4, 7, 9, 12, 14)	$V_{CC}$

Operating Temperature Range	0°C to +70°C
Storage Temperature Range	-65°C to +150°C
Power Dissipation	1W
Lead Temp. (Soldering, 10 seconds)	260°C

**Note 1:** "Absolute Maximum Ratings" indicate limits beyond which damage to the device may occur. Operating Ratings indicate conditions for which the device is functional, but do not guarantee specific performance limits.

**Electrical Characteristics**

$V_{CC}=12V$ ,  $T_A=25^\circ C$  (unless otherwise stated)

Parameter	Conditions	Min	Typ	Max	Units
Supply Voltage Range	Pin 11	9		16	V
Supply Current			35	45	mA
Zener Regulated Output Voltage	Pin 17		5.4		V
Zener Regulated Output Current				5	mA
Maximum Output Voltage	Pins 8, 13; $f=1$ kHz $V_{CC}=9V$ , Maximum Gain $V_{CC}=12V$	0.8	0.8 1.0		Vrms Vrms
Maximum Input Voltage	Pins 2, 19; $f=1$ kHz, $V_{CC} 2V$ Gain=-10 dB	1.3	1.6		Vrms
Input Resistance	Pins 2, 19; $f=1$ kHz	20	30		k $\Omega$
Output Resistance	Pins 8, 13; $f=1$ kHz		20		$\Omega$
Maximum Gain	$V(\text{Pin } 12)=V(\text{Pin } 17)$ ; $f=1$ kHz	-2	0	2	dB
Volume Control Range	$f=1$ kHz	70	75		dB
Gain Tracking	$f=1$ kHz				
Channel 1-Channel 2	0 dB through -40 dB -40 dB through -60 dB		1 2	3	dB dB
Balance Control Range	Pins 8, 13; $f=1$ kHz		1 -26	-20	dB dB
Bass Control Range (Note 3)	$f=40$ Hz, $C_b=0.39$ $\mu F$ $V(\text{Pin } 14)=V(\text{Pin } 17)$ $V(\text{Pin } 14)=0V$	12 -12	15 -15	18 -18	dB dB
Treble Control Range (Note 3)	$f=16$ kHz, $C_t=0.01$ $\mu F$ $V(\text{Pin } 4)=V(\text{Pin } 17)$ $V(\text{Pin } 4)=0V$	12 -12	15 -15	18 -18	dB dB
Total Harmonic Distortion	$f=1$ kHz, $V_{IN}=0.3$ Vrms Gain=0 dB Gain=-30 dB		0.06 0.03	0.3	% %
Channel Separation	$f=1$ kHz, Maximum Gain	60	75		dB
Signal/Noise Ratio	Unweighted 100 Hz-20 kHz Maximum Gain, 0 dB=0.3 Vrms CCIR/ARM (Note 4) Gain=0 dB, $V_{IN}=0.3$ Vrms Gain=-20 dB, $V_{IN}=1.0$ Vrms	75	80 79 72		dB dB dB
Output Noise Voltage at Minimum Gain	CCIR/ARM (Note 4)		10	16	$\mu V$
Supply Ripple Rejection	200 mVrms, 1 kHz Ripple	35	50		dB
Control Input Currents	Pins 4, 7, 9, 12, 14 ( $V=0V$ )		-0.6	-2.5	$\mu A$
Frequency Response	-1 dB (Flat Response) 20 Hz-16 kHz)		250		kHz

**Note 2:** The maximum permissible input level is dependent on tone and volume settings. See Application Notes.

**Note 3:** The tone control range is defined by capacitors  $C_b$  and  $C_t$ . See Application Notes.

**Note 4:** Gaussian noise, measured over a period of 50 ms per channel, with a CCIR filter referenced to 2 kHz and an average-responding meter.

## Typical Performance Characteristics

**Volume Control Characteristics**

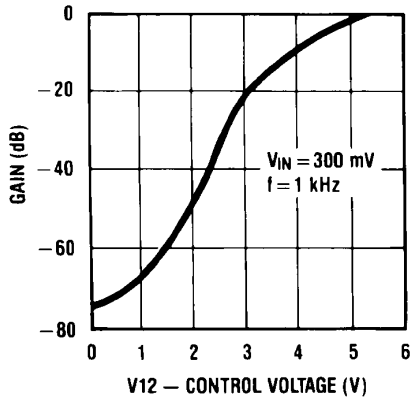

514220

**Balance Control Characteristic**

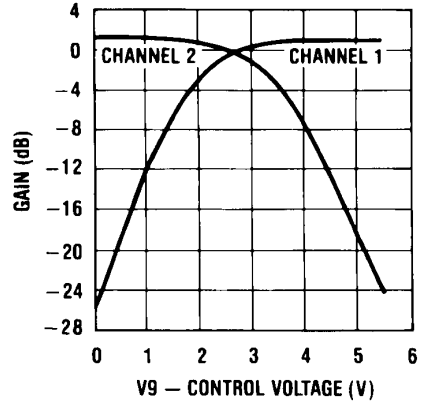

514221

**Tone Control Characteristic**

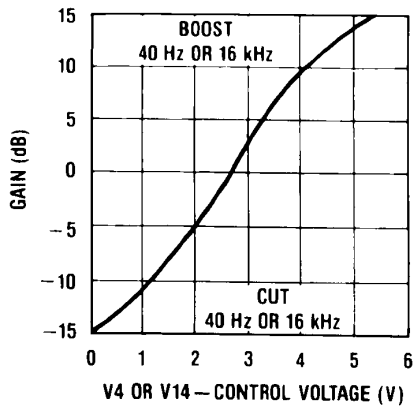

514222

**Tone Characteristic (Gain vs Frequency)**

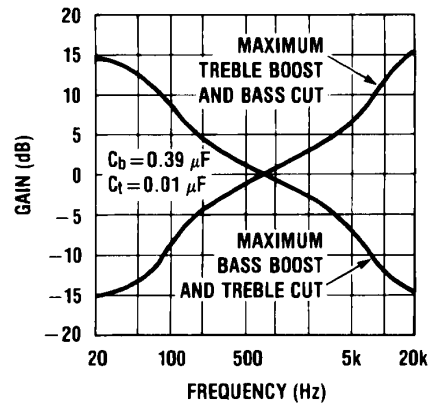

514223

**Tone Characteristic (Gain vs Frequency)**

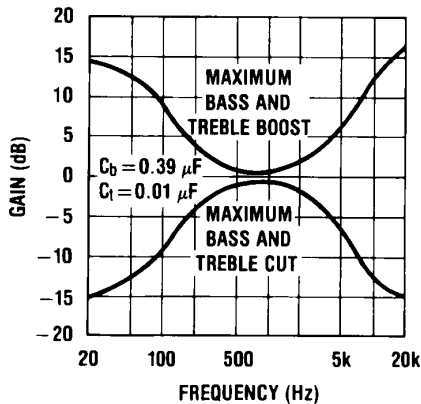

514224

**Loudness Compensated Volume Characteristic**

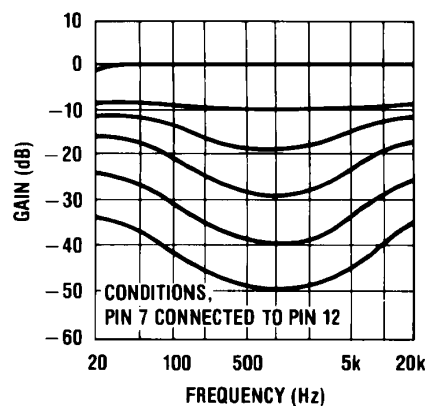

514225

Input Signal Handling vs Supply Voltage

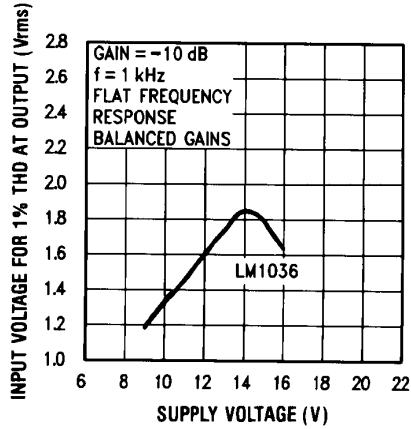

514226

THD vs Gain

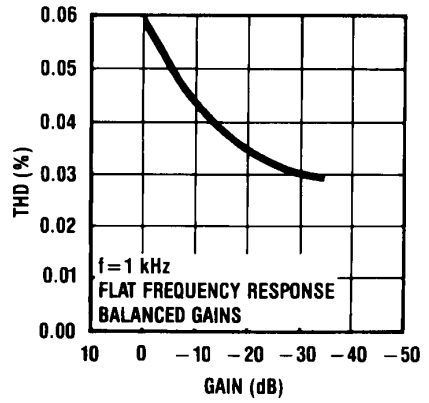

514227

Channel Separation vs Frequency

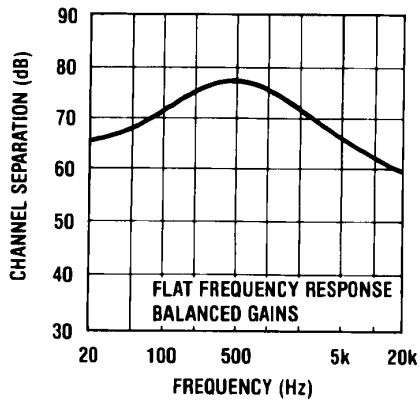

514228

Loudness Control Characteristic

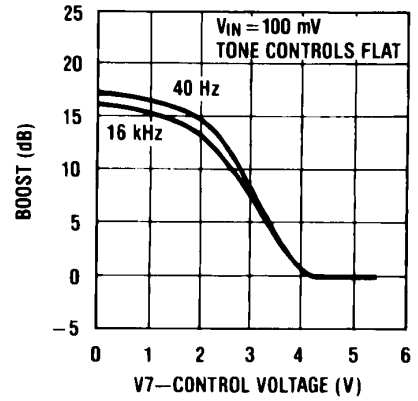

514229

Output Noise Voltage vs Gain

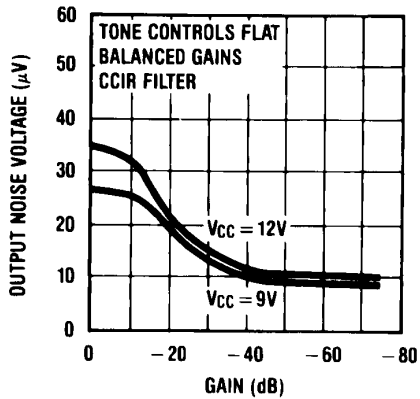

514230

THD vs Input Voltage

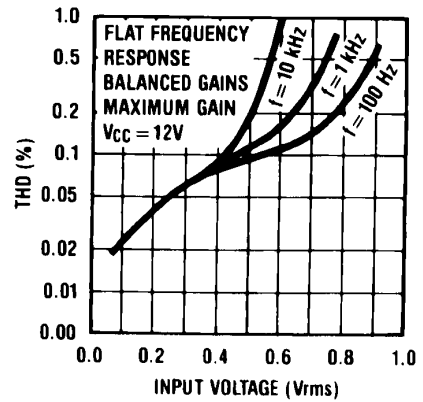

514231

## Application Notes

### TONE RESPONSE

The maximum boost and cut can be optimized for individual applications by selection of the appropriate values of  $C_t$  (treble) and  $C_b$  (bass).

The tone responses are defined by the relationships:

$$\text{Bass Response} = \frac{1 + \frac{0.00065(1 - a_b)}{j\omega C_b}}{1 + \frac{0.00065a_b}{j\omega C_b}}$$

$$\text{Treble Response} = \frac{1 + j\omega 5500(1 - a_t)C_t}{1 + j\omega 5500a_t C_t}$$

Where  $a_b = a_t = 0$  for maximum bass and treble boost respectively and  $a_b = a_t = 1$  for maximum cut.

For the values of  $C_b$  and  $C_t$  of  $0.39 \mu\text{F}$  and  $0.01 \mu\text{F}$  as shown in the Application Circuit, 15 dB of boost or cut is obtained at 40 Hz and 16 kHz.

### ZENER VOLTAGE

A zener voltage (pin 17=5.4V) is provided which may be used to bias the control potentiometers. Setting a DC level of one half of the zener voltage on the control inputs, pins 4, 9, and 14, results in the balanced gain and flat response condition. Typical spread on the zener voltage is  $\pm 100 \text{ mV}$  and this must be taken into account if control signals are used which are not referenced to the zener voltage. If this is the case, then they will need to be derived with similar accuracy.

## Application Circuit

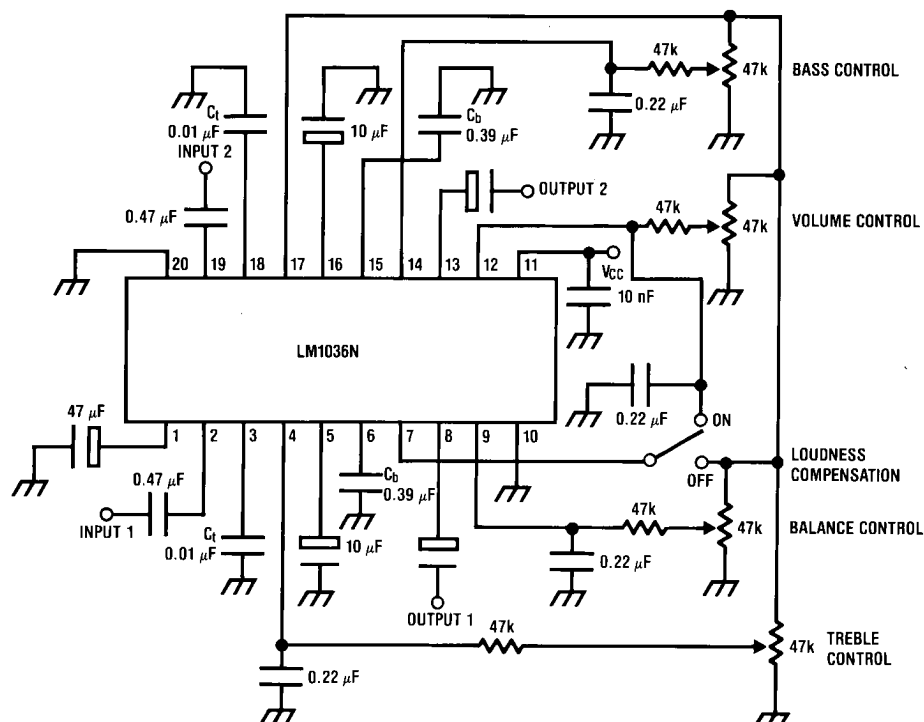

514203

### LOUDNESS COMPENSATION

A simple loudness compensation may be effected by applying a DC control voltage to pin 7. This operates on the tone control stages to produce an additional boost limited by the maximum boost defined by  $C_b$  and  $C_t$ . There is no loudness compensation when pin 7 is connected to pin 17. Pin 7 can be connected to pin 12 to give the loudness compensated volume characteristic as illustrated without the addition of further external components. (Tone settings are for flat response,  $C_b$  and  $C_t$  as given in Application Circuit.) Modification to the loudness characteristic is possible by changing the capacitors  $C_b$  and  $C_t$  for a different basic response or, by a resistor network between pins 7 and 12 for a different threshold and slope.

### SIGNAL HANDLING

The volume control function of the LM1036 is carried out in two stages, controlled by the DC voltage on pin 12, to improve signal handling capability and provide a reduction of output noise level at reduced gain. The first stage is before the tone control processing and provides an initial 15 dB of gain reduction, so ensuring that the tone sections are not overdriven by large input levels when operating with a low volume setting. Any combination of tone and volume settings may be used provided the output level does not exceed 1 Vrms,  $V_{CC}=12\text{V}$  (0.8 Vrms,  $V_{CC}=9\text{V}$ ). At reduced gain ( $<-6 \text{ dB}$ ) the input stage will overload if the input level exceeds 1.6 Vrms,  $V_{CC}=12\text{V}$  (1.1 Vrms,  $V_{CC}=9\text{V}$ ). As there is volume control on the input stages, the inputs may be operated with a lower overload margin than would otherwise be acceptable, allowing a possible improvement in signal to noise ratio.

## Applications Information

### OBTAINING MODIFIED RESPONSE CURVES

The LM1036 is a dual DC controlled bass, treble, balance and volume integrated circuit ideal for stereo audio systems.

In the various applications where the LM1036 can be used, there may be requirements for responses different to those of the standard application circuit given in the data sheet. This application section details some of the simple variations possible on the standard responses, to assist the choice of optimum characteristics for particular applications.

### TONE CONTROLS

Summarizing the relationship given in the data sheet, basically for an increase in the treble control range  $C_t$  must be increased, and for increased bass range  $C_b$  must be reduced.

Figure 1 shows the typical tone response obtained in the standard application circuit. ( $C_t=0.01 \mu\text{F}$ ,  $C_b=0.39 \mu\text{F}$ ). Response curves are given for various amounts of boost and cut.

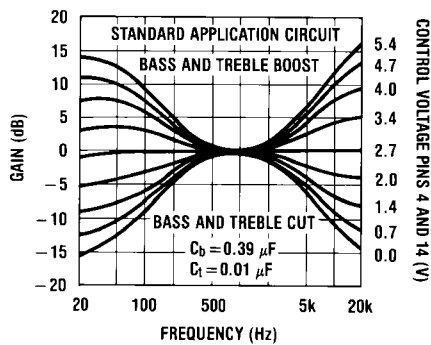

514204

FIGURE 1. Tone Characteristic (Gain vs Frequency)

Figure 2 and Figure 3 show the effect of changing the response defining capacitors  $C_t$  and  $C_b$  to  $2C_t$ ,  $C_b/2$  and  $4C_t$ ,  $C_b/4$  respectively, giving increased tone control ranges. The values of the bypass capacitors may become significant and affect the lower frequencies in the bass response curves.

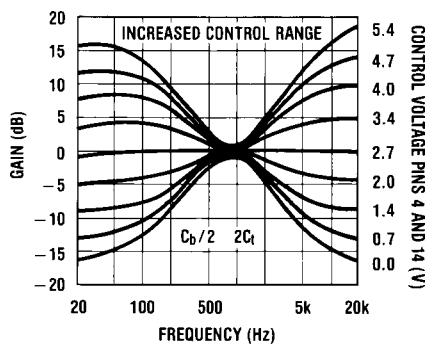

514205

FIGURE 2. Tone Characteristic (Gain vs Frequency)

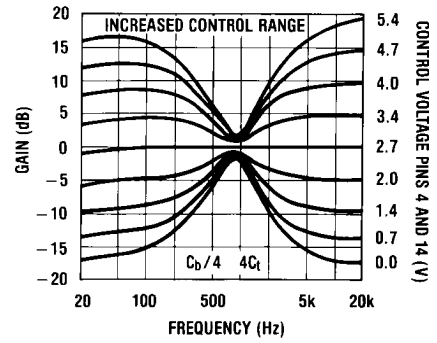

514206

FIGURE 3. Tone Characteristic (Gain vs Frequency)

Figure 4 shows the effect of changing  $C_t$  and  $C_b$  in the opposite direction to  $C_t/2$ ,  $2C_b$  respectively giving reduced control ranges. The various results corresponding to the different  $C_t$  and  $C_b$  values may be mixed if it is required to give a particular emphasis to, for example, the bass control. The particular case with  $C_b/2$ ,  $C_t$  is illustrated in Figure 5.

### Restriction of Tone Control Action at High or Low Frequencies

It may be desired in some applications to level off the tone responses above or below certain frequencies for example to reduce high frequency noise.

This may be achieved for the treble response by including a resistor in series with  $C_t$ . The treble boost and cut will be 3 dB less than the standard circuit when  $R=X_C$ .

A similar effect may be obtained for the bass response by reducing the value of the AC bypass capacitors on pins 5 (channel 1) and 16 (channel 2). The internal resistance at these pins is 1.3 k $\Omega$  and the bass boost/cut will be approximately 3 dB less with  $X_C$  at this value. An example of such modified response curves is shown in Figure 6. The input coupling capacitors may also modify the low frequency response.

It will be seen from Figure 2 and Figure 3 that modifying  $C_t$  and  $C_b$  for greater control range also has the effect of flattening the tone control extremes and this may be utilized, with or without additional modification as outlined above, for the most suitable tone control range and response shape.

### Other Advantages of DC Controls

The DC controls make the addition of other features easy to arrange. For example, the negative-going peaks of the output amplifiers may be detected below a certain level, and used to bias back the bass control from a high boost condition, to prevent overloading the speaker with low frequency components.

### LOUDNESS CONTROL

The loudness control is achieved through control of the tone sections by the voltage applied to pin 7; therefore, the tone and loudness functions are not independent. There is normally 1 dB more bass than treble boost (40 Hz–16 kHz) with loudness control in the standard circuit. If a greater difference is desired, it is necessary to introduce an offset by means of  $C_t$  or  $C_b$  or by changing the nominal control voltage ranges.

Figure 7 shows the typical loudness curves obtained in the standard application circuit at various volume levels ( $C_b=0.39 \mu\text{F}$ ).

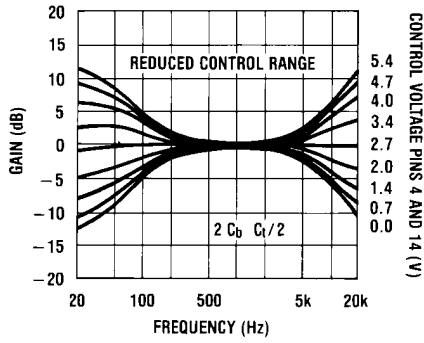

514207

FIGURE 4. Tone Characteristic (Gain vs Frequency)

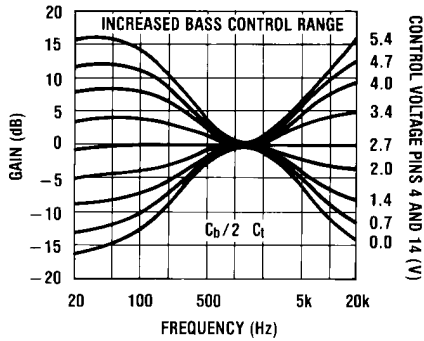

514208

FIGURE 5. Tone Characteristic (Gain vs Frequency)

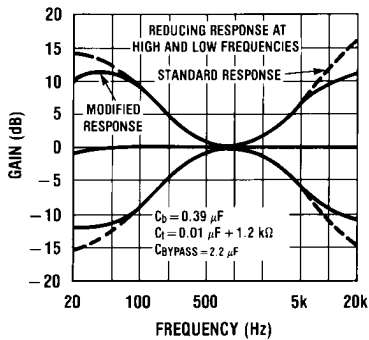

514209

FIGURE 6. Tone Characteristic (Gain vs Frequency)

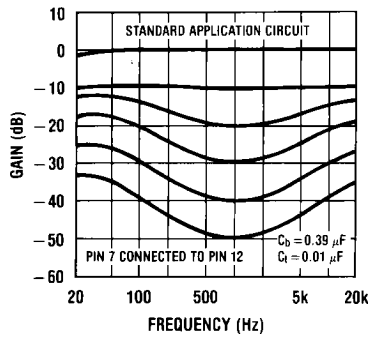

514210

FIGURE 7. Loudness Compensated Volume Characteristic

Figure 8 and Figure 9 illustrate the loudness characteristics obtained with  $C_b$  changed to  $C_b/2$  and  $C_b/4$  respectively,  $C_t$  being kept at the nominal  $0.01 \mu\text{F}$ . These values naturally modify the bass tone response as in Figure 2 and Figure 3.

With pins 7 (loudness) and 12 (volume) directly connected, loudness control starts at typically  $-8 \text{ dB}$  volume, with most of the control action complete by  $-30 \text{ dB}$ .

Figure 10 and Figure 11 show the effect of resistively offsetting the voltage applied to pin 7 towards the control reference voltage (pin 17). Because the control inputs are high impedance, this is easily done and high value resistors may be used for minimal additional loading. It is possible to reduce the rate of onset of control to extend the active range to  $-50 \text{ dB}$  volume control and below.

The control on pin 7 may also be divided down towards ground bringing the control action on earlier. This is illustrated in Figure 12, With a suitable level shifting network between pins 12 and 7, the onset of loudness control and its rate of change may be readily modified.

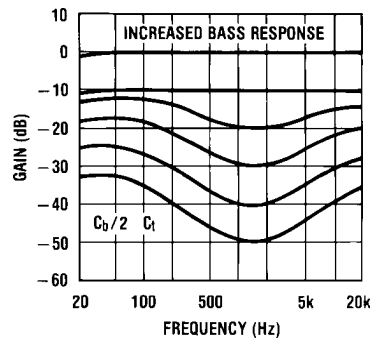

514211

FIGURE 8. Loudness Compensated Volume Characteristic

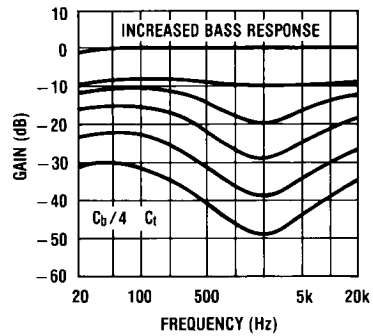

514212

FIGURE 9. Loudness Compensated Volume Characteristic

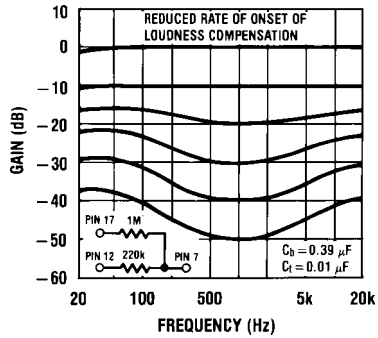

514213

FIGURE 10. Loudness Compensated Volume Characteristic

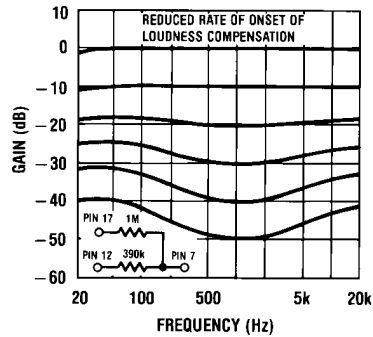

514214

FIGURE 11. Loudness Compensated Volume Characteristic

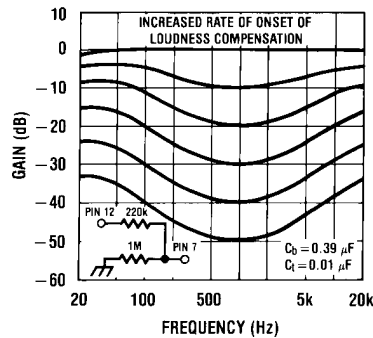

514215

FIGURE 12. Loudness Compensated Volume Characteristic

When adjusted for maximum boost in the usual application circuit, the LM1036 cannot give additional boost from the loudness control with reducing gain. If it is required, some additional boost can be obtained by restricting the tone control range and modifying  $C_t$ ,  $C_b$ , to compensate. A circuit illustrating this for the case of bass boost is shown in Figure 13. The resulting responses are given in Figure 14 showing the continuing loudness control action possible with bass boost previously applied.

#### USE OF THE LM1036 ABOVE AUDIO FREQUENCIES

The LM1036 has a basic response typically 1 dB down at 250 kHz (tone controls flat) and therefore by scaling  $C_b$  and  $C_t$ , it is possible to arrange for operation over a wide frequency range for possible use in wide band equalization applications. As an example Figure 15 shows the responses obtained centered on 10 kHz with  $C_b=0.039 \mu\text{F}$  and  $C_t=0.001 \mu\text{F}$ .



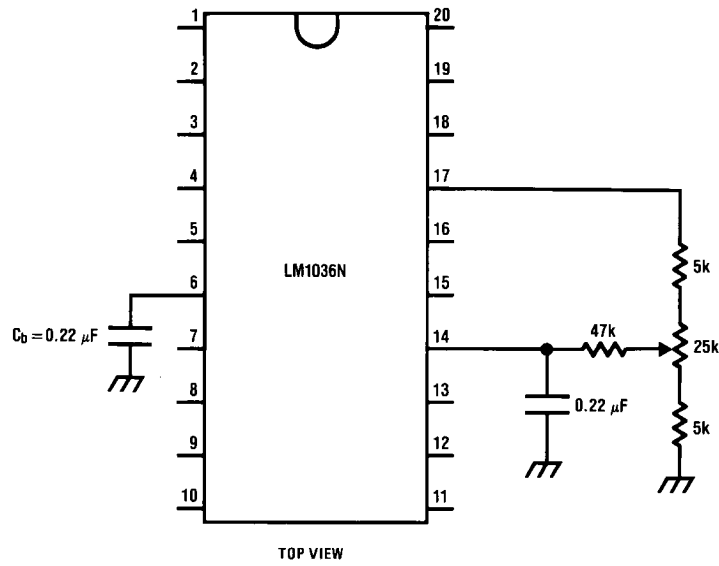

514216

FIGURE 13. Modified Application Circuit for Additional Bass Boost with Loudness Control

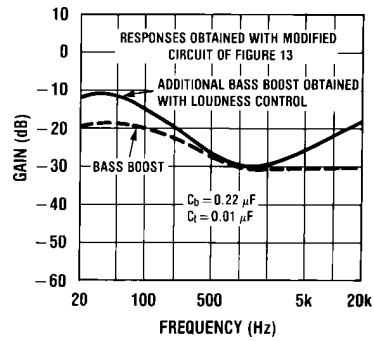

514217

FIGURE 14. Loudness Compensated Volume Characteristic

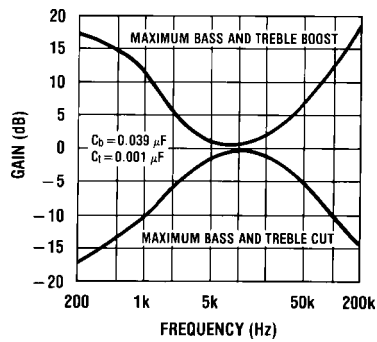

514218

FIGURE 15. Tone Characteristic (Gain vs Frequency)

# Simplified Schematic Diagram

(One Channel)

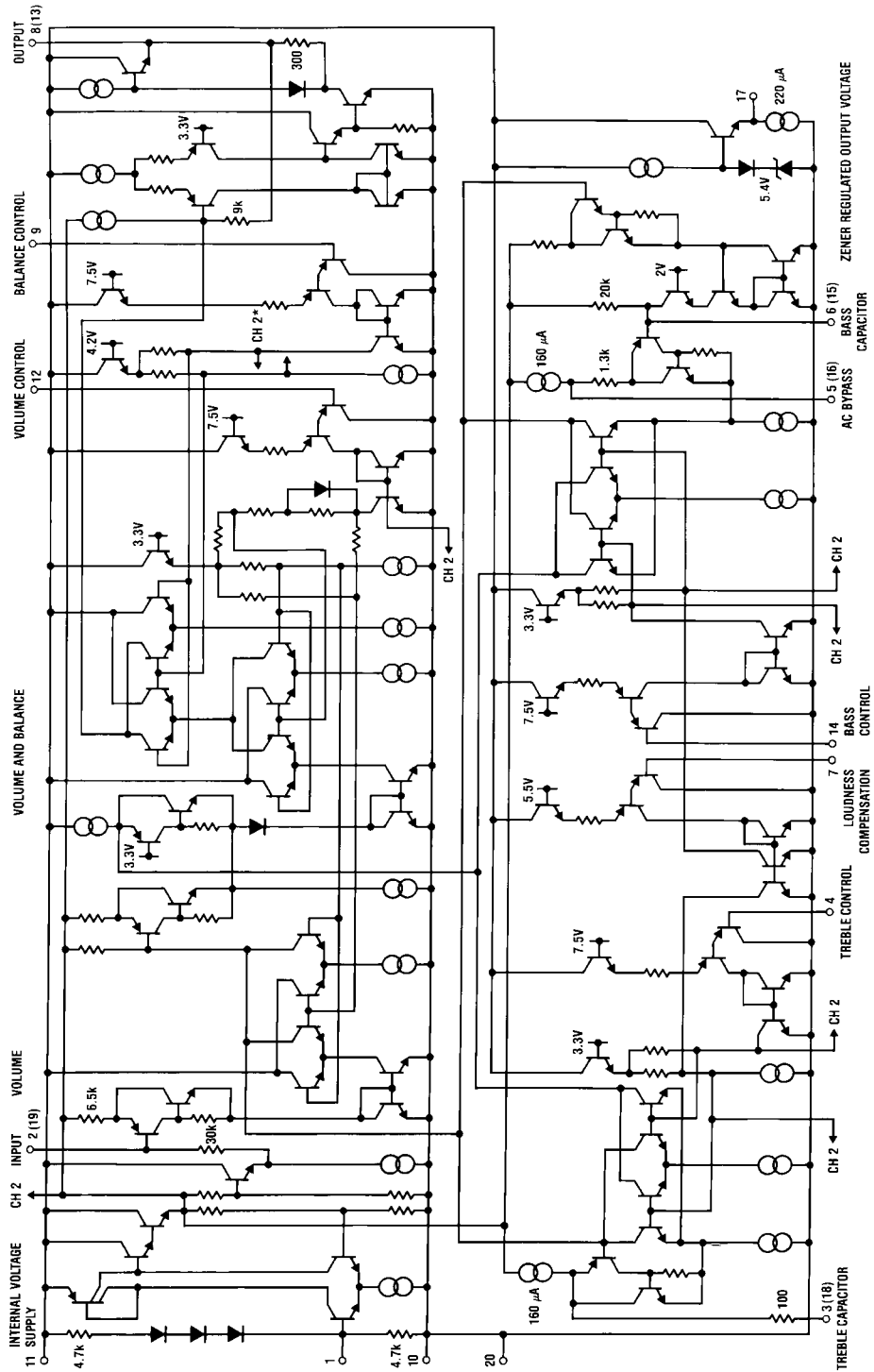

\*Connections reversed

514219



## Notes

For more National Semiconductor product information and proven design tools, visit the following Web sites at:

Products		Design Support	
Amplifiers	<a href="http://www.national.com/amplifiers">www.national.com/amplifiers</a>	WEBENCH	<a href="http://www.national.com/webench">www.national.com/webench</a>
Audio	<a href="http://www.national.com/audio">www.national.com/audio</a>	Analog University	<a href="http://www.national.com/AU">www.national.com/AU</a>
Clock Conditioners	<a href="http://www.national.com/timing">www.national.com/timing</a>	App Notes	<a href="http://www.national.com/appnotes">www.national.com/appnotes</a>
Data Converters	<a href="http://www.national.com/adc">www.national.com/adc</a>	Distributors	<a href="http://www.national.com/contacts">www.national.com/contacts</a>
Displays	<a href="http://www.national.com/displays">www.national.com/displays</a>	Green Compliance	<a href="http://www.national.com/quality/green">www.national.com/quality/green</a>
Ethernet	<a href="http://www.national.com/ethernet">www.national.com/ethernet</a>	Packaging	<a href="http://www.national.com/packaging">www.national.com/packaging</a>
Interface	<a href="http://www.national.com/interface">www.national.com/interface</a>	Quality and Reliability	<a href="http://www.national.com/quality">www.national.com/quality</a>
LVDS	<a href="http://www.national.com/lvds">www.national.com/lvds</a>	Reference Designs	<a href="http://www.national.com/refdesigns">www.national.com/refdesigns</a>
Power Management	<a href="http://www.national.com/power">www.national.com/power</a>	Feedback	<a href="http://www.national.com/feedback">www.national.com/feedback</a>
Switching Regulators	<a href="http://www.national.com/switchers">www.national.com/switchers</a>		
LDOs	<a href="http://www.national.com/ldo">www.national.com/ldo</a>		
LED Lighting	<a href="http://www.national.com/led">www.national.com/led</a>		
PowerWise	<a href="http://www.national.com/powerwise">www.national.com/powerwise</a>		
Serial Digital Interface (SDI)	<a href="http://www.national.com/sdi">www.national.com/sdi</a>		
Temperature Sensors	<a href="http://www.national.com/tempsensors">www.national.com/tempsensors</a>		
Wireless (PLL/VCO)	<a href="http://www.national.com/wireless">www.national.com/wireless</a>		

THE CONTENTS OF THIS DOCUMENT ARE PROVIDED IN CONNECTION WITH NATIONAL SEMICONDUCTOR CORPORATION ("NATIONAL") PRODUCTS. NATIONAL MAKES NO REPRESENTATIONS OR WARRANTIES WITH RESPECT TO THE ACCURACY OR COMPLETENESS OF THE CONTENTS OF THIS PUBLICATION AND RESERVES THE RIGHT TO MAKE CHANGES TO SPECIFICATIONS AND PRODUCT DESCRIPTIONS AT ANY TIME WITHOUT NOTICE. NO LICENSE, WHETHER EXPRESS, IMPLIED, ARISING BY ESTOPPEL OR OTHERWISE, TO ANY INTELLECTUAL PROPERTY RIGHTS IS GRANTED BY THIS DOCUMENT.

TESTING AND OTHER QUALITY CONTROLS ARE USED TO THE EXTENT NATIONAL DEEMS NECESSARY TO SUPPORT NATIONAL'S PRODUCT WARRANTY. EXCEPT WHERE MANDATED BY GOVERNMENT REQUIREMENTS, TESTING OF ALL PARAMETERS OF EACH PRODUCT IS NOT NECESSARILY PERFORMED. NATIONAL ASSUMES NO LIABILITY FOR APPLICATIONS ASSISTANCE OR BUYER PRODUCT DESIGN. BUYERS ARE RESPONSIBLE FOR THEIR PRODUCTS AND APPLICATIONS USING NATIONAL COMPONENTS. PRIOR TO USING OR DISTRIBUTING ANY PRODUCTS THAT INCLUDE NATIONAL COMPONENTS, BUYERS SHOULD PROVIDE ADEQUATE DESIGN, TESTING AND OPERATING SAFEGUARDS.

EXCEPT AS PROVIDED IN NATIONAL'S TERMS AND CONDITIONS OF SALE FOR SUCH PRODUCTS, NATIONAL ASSUMES NO LIABILITY WHATSOEVER, AND NATIONAL DISCLAIMS ANY EXPRESS OR IMPLIED WARRANTY RELATING TO THE SALE AND/OR USE OF NATIONAL PRODUCTS INCLUDING LIABILITY OR WARRANTIES RELATING TO FITNESS FOR A PARTICULAR PURPOSE, MERCHANTABILITY, OR INFRINGEMENT OF ANY PATENT, COPYRIGHT OR OTHER INTELLECTUAL PROPERTY RIGHT.

### LIFE SUPPORT POLICY

**NATIONAL'S PRODUCTS ARE NOT AUTHORIZED FOR USE AS CRITICAL COMPONENTS IN LIFE SUPPORT DEVICES OR SYSTEMS WITHOUT THE EXPRESS PRIOR WRITTEN APPROVAL OF THE CHIEF EXECUTIVE OFFICER AND GENERAL COUNSEL OF NATIONAL SEMICONDUCTOR CORPORATION.** As used herein:

Life support devices or systems are devices which (a) are intended for surgical implant into the body, or (b) support or sustain life and whose failure to perform when properly used in accordance with instructions for use provided in the labeling can be reasonably expected to result in a significant injury to the user. A critical component is any component in a life support device or system whose failure to perform can be reasonably expected to cause the failure of the life support device or system or to affect its safety or effectiveness.

National Semiconductor and the National Semiconductor logo are registered trademarks of National Semiconductor Corporation. All other brand or product names may be trademarks or registered trademarks of their respective holders.

Copyright© 2008 National Semiconductor Corporation

For the most current product information visit us at [www.national.com](http://www.national.com)



**National Semiconductor  
Americas Technical  
Support Center**  
Email:  
[new.feedback@nsc.com](mailto:new.feedback@nsc.com)  
Tel: 1-800-272-9959

**National Semiconductor Europe  
Technical Support Center**  
Email: [europe.support@nsc.com](mailto:europe.support@nsc.com)  
German Tel: +49 (0) 180 5010 771  
English Tel: +44 (0) 870 850 4288

**National Semiconductor Asia  
Pacific Technical Support Center**  
Email: [ap.support@nsc.com](mailto:ap.support@nsc.com)

**National Semiconductor Japan  
Technical Support Center**  
Email: [jpn.feedback@nsc.com](mailto:jpn.feedback@nsc.com)