

International
IR Rectifier

SMPS MOSFET

IRFP31N50L

PD - 94081

HEXFET® Power MOSFET

Applications

- Switch Mode Power Supply (SMPS)
- Uninterruptible Power Supply
- High Speed Power Switching
- ZVS and High Frequency Circuit
- PWM Inverters

V_{DSS}	$R_{DS(on)}$ typ.	I_D
500V	0.15Ω	31A

Benefits

- Low Gate Charge Q_g results in Simple Drive Requirement
- Improved Gate, Avalanche and Dynamic dv/dt Ruggedness
- Fully Characterized Capacitance and Avalanche Voltage and Current
- Low T_{rr} and Soft Diode Recovery
- High Performance Optimised Anti-parallel Diode



Absolute Maximum Ratings

	Parameter	Max.	Units
I_D @ $T_C = 25^\circ\text{C}$	Continuous Drain Current, V_{GS} @ 10V	31	A
I_D @ $T_C = 100^\circ\text{C}$	Continuous Drain Current, V_{GS} @ 10V	20	
I_{DM}	Pulsed Drain Current ①	124	
P_D @ $T_C = 25^\circ\text{C}$	Power Dissipation	460	W
	Linear Derating Factor	3.7	W/°C
V_{GS}	Gate-to-Source Voltage	± 30	V
dv/dt	Peak Diode Recovery dv/dt ③	19	V/ns
T_J T_{STG}	Operating Junction and Storage Temperature Range	-55 to + 150	°C
	Soldering Temperature, for 10 seconds (1.6mm from case)	300	
	Mounting torque, 6-32 or M3 screw	10 lbf•in (1.1N•m)	

Diode Characteristics

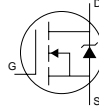
Symbol	Parameter	Min.	Typ.	Max.	Units	Conditions
I_S	Continuous Source Current (Body Diode)	—	—	31	A	MOSFET symbol showing the integral reverse p-n junction diode. 
I_{SM}	Pulsed Source Current (Body Diode) ①	—	—	124		
V_{SD}	Diode Forward Voltage	—	—	1.5	V	$T_J = 25^\circ\text{C}$, $I_S = 31\text{A}$, $V_{GS} = 0\text{V}$ ④
t_{rr}	Reverse Recovery Time	—	170	250	ns	$T_J = 25^\circ\text{C}$ $I_F = 31\text{A}$
		—	220	330		$T_J = 125^\circ\text{C}$ $di/dt = 100\text{A}/\mu\text{s}$ ④
Q_{rr}	Reverse Recovery Charge	—	570	860	nC	$T_J = 25^\circ\text{C}$
		—	1.2	1.8		$T_J = 125^\circ\text{C}$
I_{RRM}	Reverse Recovery Current	—	7.9	12	A	
t_{on}	Forward Turn-On Time	Intrinsic turn-on time is negligible (turn-on is dominated by $L_S + L_D$)				

Typical SMPS Topologies

- Bridge Converters
- All Zero Voltage Switching

www.irf.com

1

05/23/01

www.DataSheet4U.com

IRFP31N50L

International
IR RectifierStatic @ $T_J = 25^\circ\text{C}$ (unless otherwise specified)

Symbol	Parameter	Min.	Typ.	Max.	Units	Conditions
$V_{(BR)DSS}$	Drain-to-Source Breakdown Voltage	500	—	—	V	$V_{GS} = 0V, I_D = 250\mu A$
$\Delta V_{(BR)DSS}/\Delta T_J$	Breakdown Voltage Temp. Coefficient	—	0.28	—	V/°C	Reference to $25^\circ\text{C}, I_D = 1\text{mA}$ Ⓞ
$R_{DS(on)}$	Static Drain-to-Source On-Resistance	—	0.15	0.18	Ω	$V_{GS} = 10V, I_D = 19A$ ④
$V_{GS(th)}$	Gate Threshold Voltage	3.0	—	5.0	V	$V_{DS} = V_{GS}, I_D = 250\mu A$
I_{DSS}	Drain-to-Source Leakage Current	—	—	50	μA	$V_{DS} = 500V, V_{GS} = 0V$
		—	—	2.0	mA	$V_{DS} = 400V, V_{GS} = 0V, T_J = 125^\circ\text{C}$
I_{GSS}	Gate-to-Source Forward Leakage	—	—	100	nA	$V_{GS} = 30V$
	Gate-to-Source Reverse Leakage	—	—	-100		$V_{GS} = -30V$

Dynamic @ $T_J = 25^\circ\text{C}$ (unless otherwise specified)

Symbol	Parameter	Min.	Typ.	Max.	Units	Conditions
g_{fs}	Forward Transconductance	15	—	—	S	$V_{DS} = 50V, I_D = 19A$ ④
Q_g	Total Gate Charge	—	—	210	nC	$I_D = 31A$ $V_{DS} = 400V$
Q_{gs}	Gate-to-Source Charge	—	—	58		$V_{GS} = 10V, \text{See Fig. 6 and 13}$ ④
Q_{gd}	Gate-to-Drain ("Miller") Charge	—	—	100		
$t_{d(on)}$	Turn-On Delay Time	—	28	—	ns	$V_{DD} = 250V$ $I_D = 31A$ $R_G = 4.3\Omega$ $V_{GS} = 10V, \text{See Fig. 10}$ ④
t_r	Rise Time	—	115	—		
$t_{d(off)}$	Turn-Off Delay Time	—	54	—		
t_f	Fall Time	—	53	—		
C_{iss}	Input Capacitance	—	5000	—	pF	$V_{GS} = 0V$ $V_{DS} = 25V$ $f = 1.0\text{MHz}, \text{See Fig. 5}$
C_{oss}	Output Capacitance	—	553	—		$V_{GS} = 0V, V_{DS} = 1.0V, f = 1.0\text{MHz}$
C_{riss}	Reverse Transfer Capacitance	—	59	—		$V_{GS} = 0V, V_{DS} = 400V, f = 1.0\text{MHz}$
C_{oss}	Output Capacitance	—	6630	—		$V_{GS} = 0V, V_{DS} = 0V \text{ to } 400V$ ⑤
C_{oss}	Output Capacitance	—	155	—		
$C_{oss \text{ eff.}}$	Effective Output Capacitance	—	276	—		

Avalanche Characteristics

Symbol	Parameter	Typ.	Max.	Units
E_{AS}	Single Pulse Avalanche Energy②	—	460	mJ
I_{AR}	Avalanche Current①	—	31	A
E_{AR}	Repetitive Avalanche Energy①	—	46	mJ

Thermal Resistance

Symbol	Parameter	Typ.	Max.	Units
$R_{\theta JC}$	Junction-to-Case	—	0.26	°C/W
$R_{\theta CS}$	Case-to-Sink, Flat, Greased Surface	0.24	—	
$R_{\theta JA}$	Junction-to-Ambient	—	40	

Notes:

- ① Repetitive rating; pulse width limited by max. junction temperature. (See Fig. 11)
- ② Starting $T_J = 25^\circ\text{C}$, $L = 1\text{mH}$, $R_G = 25\Omega$, $I_{AS} = 31A$ (See Figure 12a).
- ③ $I_{SD} = 31A$, $di/dt \leq 422A/\mu s$, $V_{DD} \leq V_{(BR)DSS}$, $T_J \leq 150^\circ\text{C}$.
- ④ Pulse width $\leq 300\mu s$; duty cycle $\leq 2\%$.
- ⑤ $C_{oss \text{ eff.}}$ is a fixed capacitance that gives the same charging time as C_{oss} while V_{DS} is rising from 0 to 80% V_{DSS} .

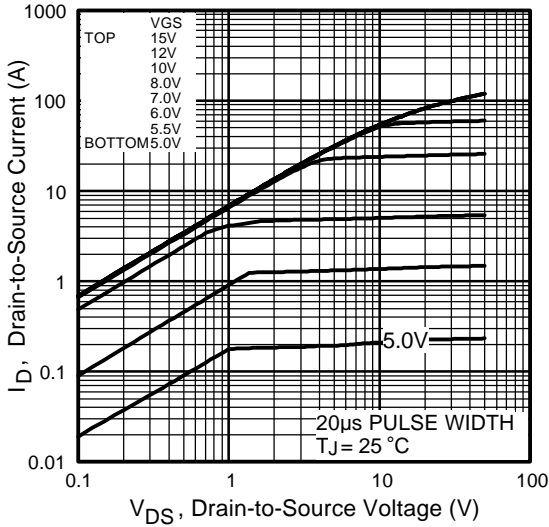

Fig 1. Typical Output Characteristics

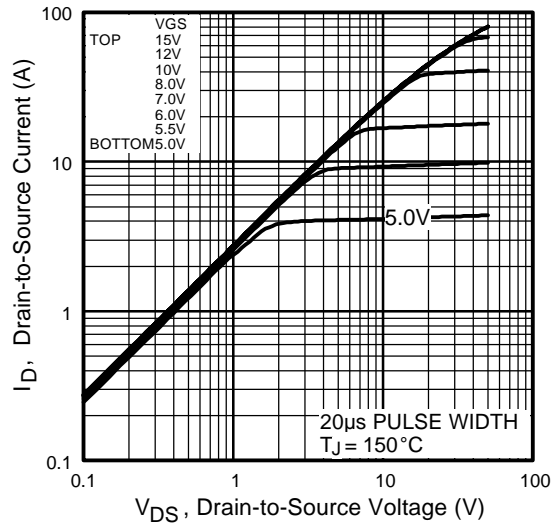

Fig 2. Typical Output Characteristics

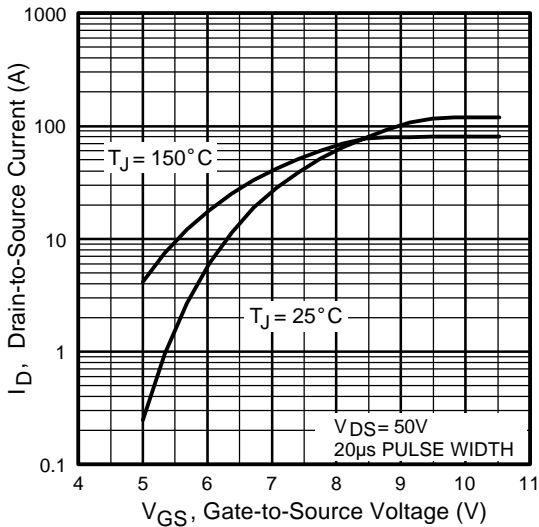

Fig 3. Typical Transfer Characteristics

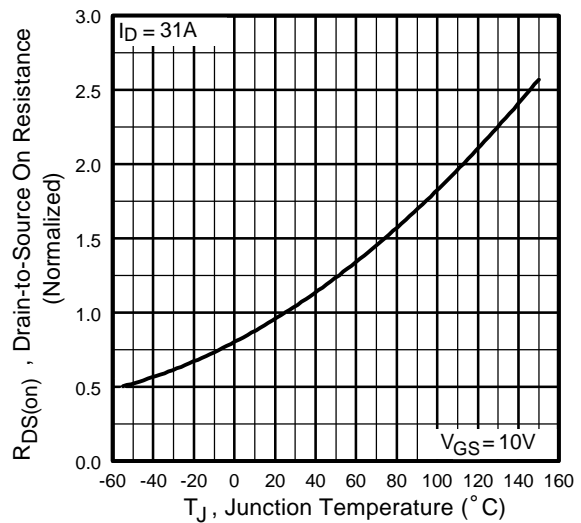

Fig 4. Normalized On-Resistance Vs. Temperature

IRFP31N50L

International
IR Rectifier

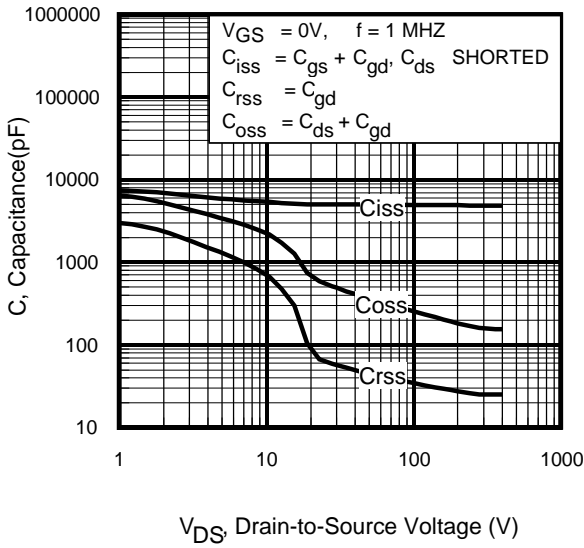

Fig 5. Typical Capacitance Vs. Drain-to-Source Voltage

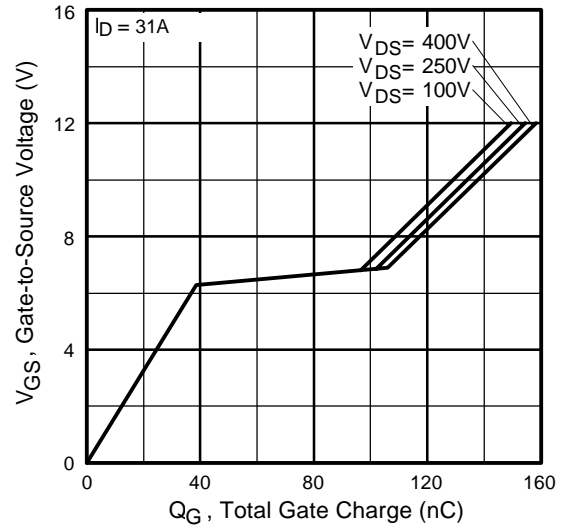

Fig 6. Typical Gate Charge Vs. Gate-to-Source Voltage

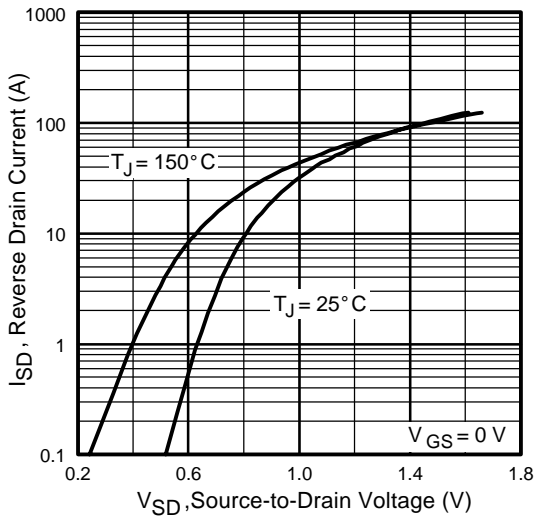

Fig 7. Typical Source-Drain Diode Forward Voltage

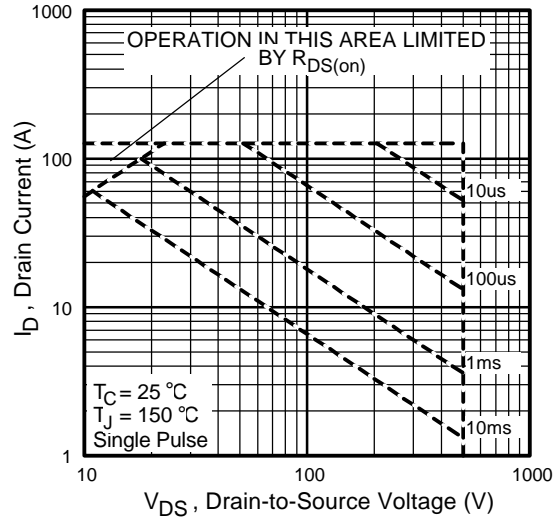

Fig 8. Maximum Safe Operating Area

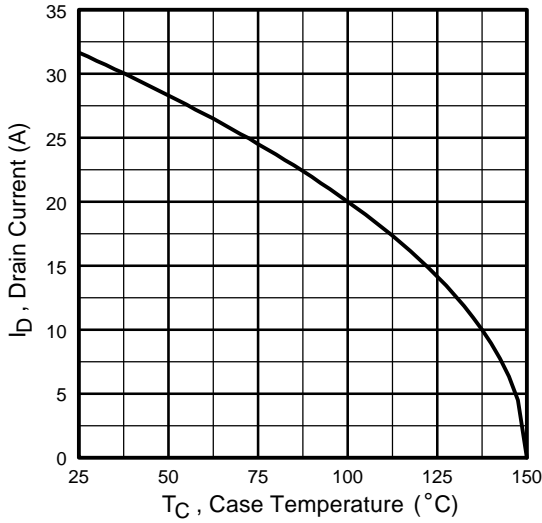

Fig 9. Maximum Drain Current Vs. Case Temperature

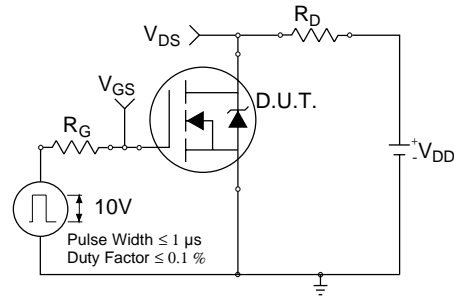

Fig 10a. Switching Time Test Circuit

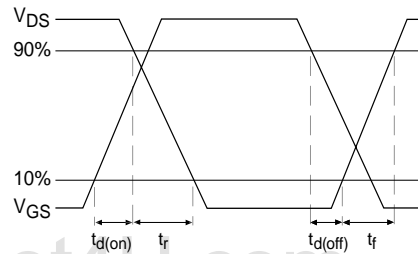

Fig 10b. Switching Time Waveforms

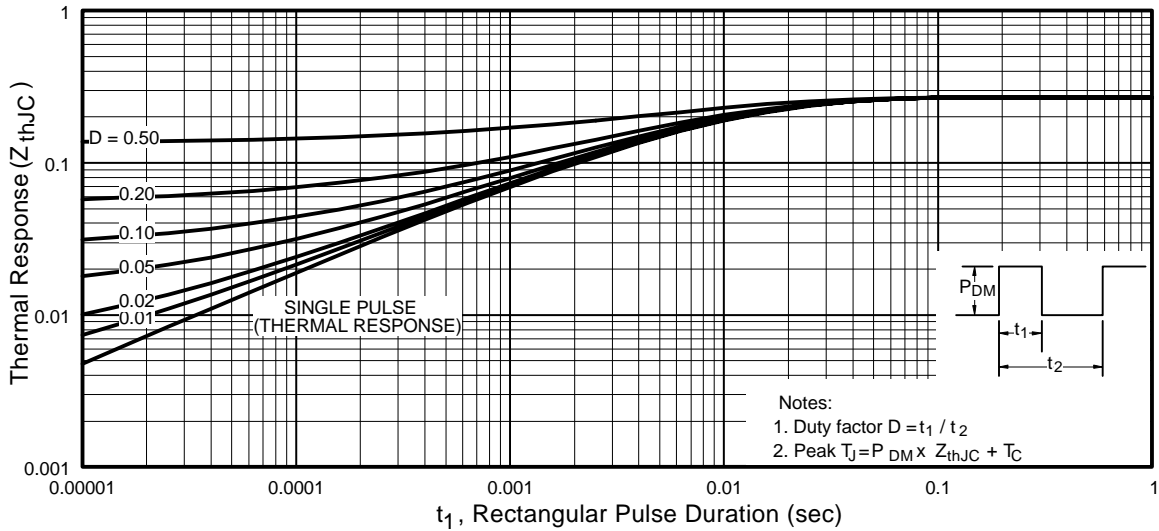

Fig 11. Maximum Effective Transient Thermal Impedance, Junction-to-Case

IRFP31N50L

International
IR Rectifier

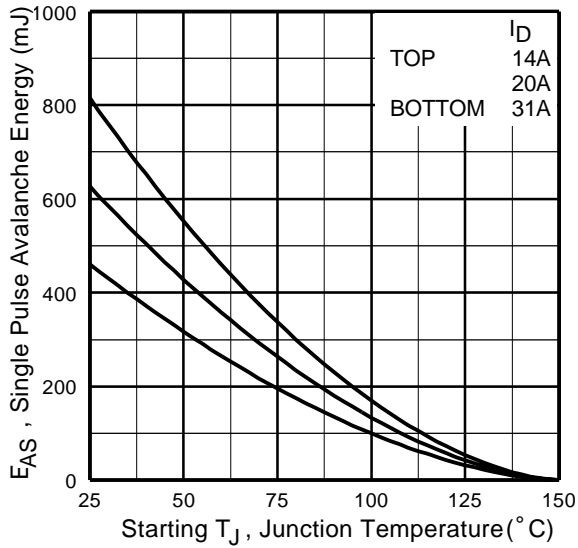

Fig 12a. Maximum Avalanche Energy Vs. Drain Current

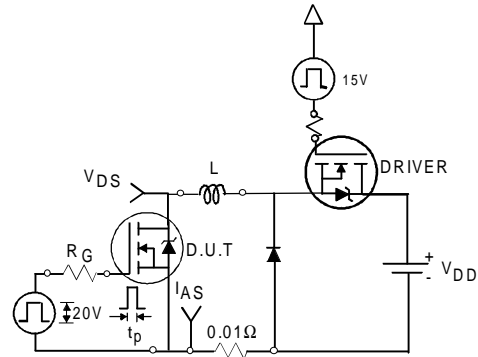

Fig 12c. Unclamped Inductive Test Circuit

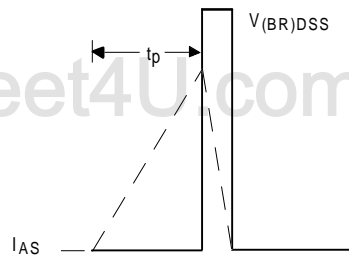

Fig 12d. Unclamped Inductive Waveforms

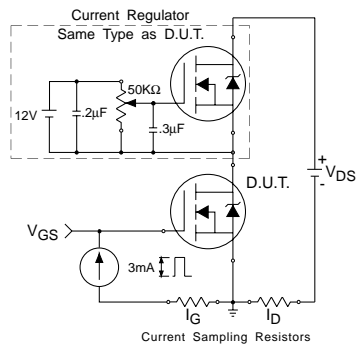

Fig 13a. Gate Charge Test Circuit

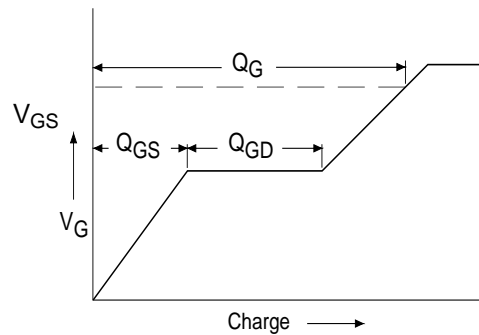
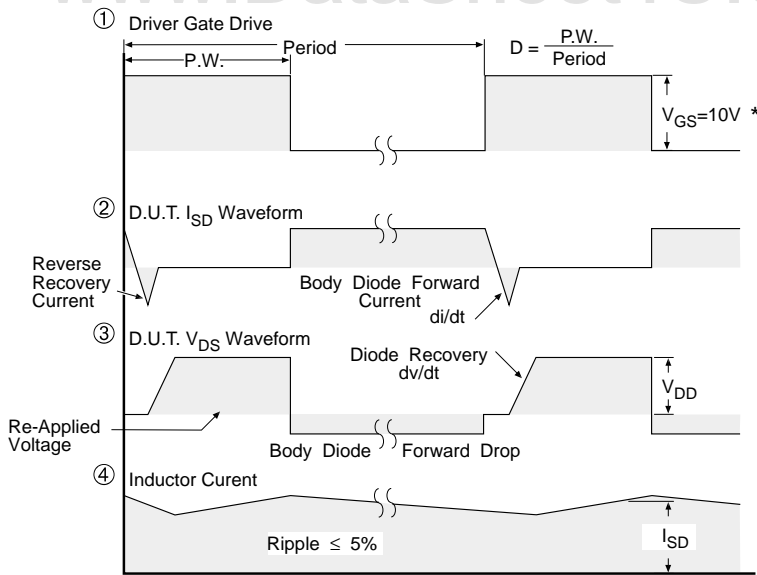
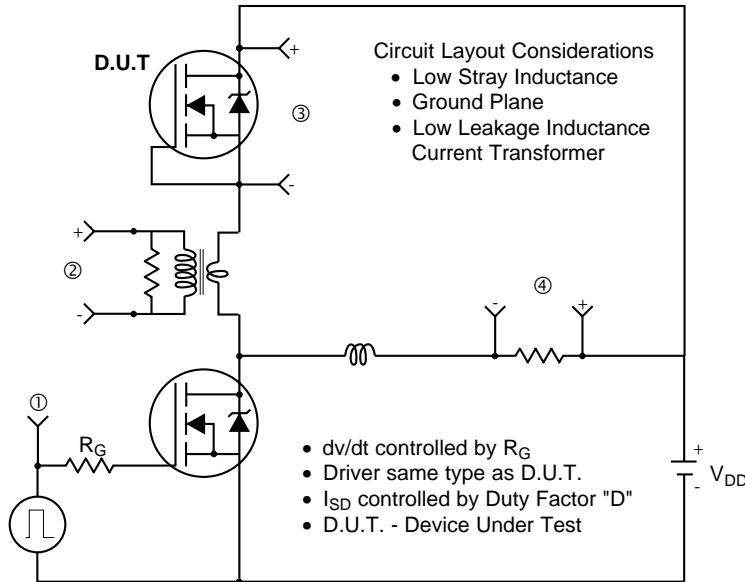

Fig 13b. Basic Gate Charge Waveform

Peak Diode Recovery dv/dt Test Circuit



* $V_{GS} = 5V$ for Logic Level Devices

Fig 14. For N-Channel HEXFET® Power MOSFETs

IRFP31N50L

International
IR Rectifier

TO - 247 Package Outline

Dimensions are shown in millimeters (inches)

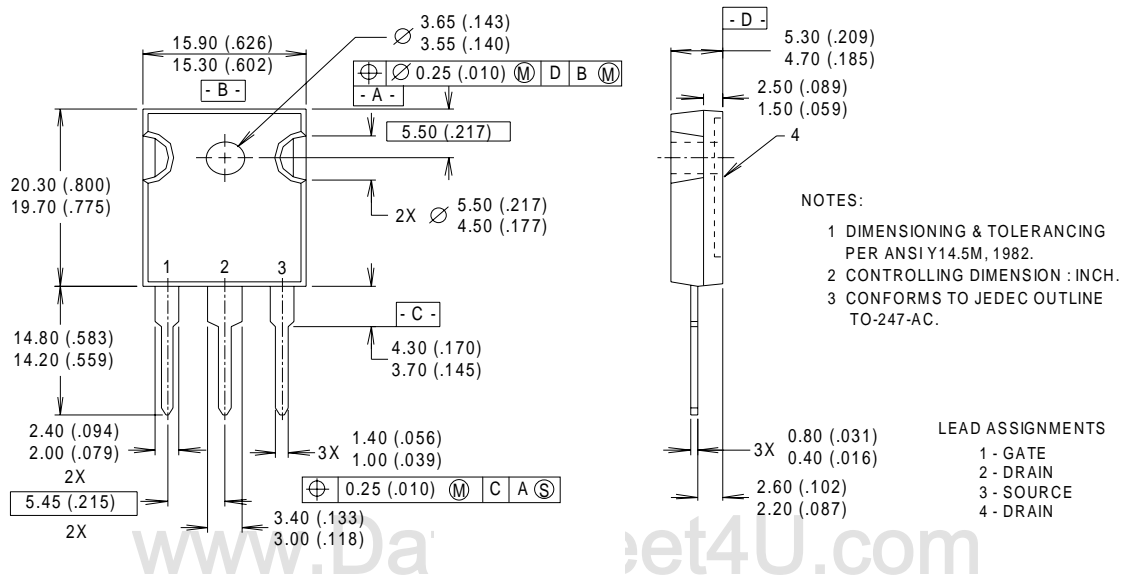

Notes:

- ① Repetitive rating; pulse width limited by max. junction temperature.
- ② Starting $T_J = 25^\circ\text{C}$, $L = 4.3\text{mH}$
 $R_G = 25\Omega$, $I_{AS} = 24\text{A}$.
- ③ $I_{SD} = 24\text{A}$, $di/dt \leq \text{TBD A}/\mu\text{s}$, $V_{DD} \leq V_{(BR)DSS}$,
 $T_J \leq 150^\circ\text{C}$
- ④ Pulse width $\leq 300\mu\text{s}$; duty cycle $\leq 2\%$.
- ⑤ C_{OSS} eff. is a fixed capacitance that gives the same charging time as C_{OSS} while V_{DS} is rising from 0 to 80% V_{DSS}
- ⑥ Calculated continuous current based on maximum allowable junction temperature. Package limitation current is 90A

Data and specifications subject to change without notice.
This product has been designed and qualified for the industrial market.
Qualification Standards can be found on IR's Web site.

International
IR Rectifier

IR WORLD HEADQUARTERS: 233 Kansas St., El Segundo, California 90245, USA Tel: (310) 252-7105
TAC Fax: (310) 252-7903

Visit us at www.irf.com for sales contact information.05/01

www.irf.com