

# Plastic Optical Fiber Cable and Accessories for Versatile Link

## Technical Data

### Features

- **Compatible with Agilent Versatile Link Family of Connectors and Fiber Optic Components**
- **1 mm Diameter Plastic Optical Fiber (POF) in Two Grades: Low Cost Standard POF with 0.22 dB/m Typical Attenuation, or High Performance Extra Low Loss POF with 0.19 dB/m Typical Attenuation**

### Applications

- **Industrial Data Links for Factory Automation and Plant Control**
- **Intra-System Links; Board-to-Board, Rack-to-Rack**
- **Telecommunications Switching Systems**
- **Computer-to-Peripheral Data Links, PC Bus Extension**
- **Proprietary LANs**
- **Digitized Video**
- **Medical Instruments**
- **Reduction of Lightning and Voltage Transient Susceptibility**
- **High Voltage Isolation**

### Cable Description

The HFBR-R/EXXYYY series of plastic fiber optic cables are constructed of a single step-index fiber sheathed in a black polyethylene jacket. The duplex fiber consists of two simplex fibers joined with a zipcord web.

Standard attenuation and extra low loss POF cables are identical except for attenuation specifications.

Polyethylene jackets on all plastic fiber cables comply with UL VW-1 flame retardant specification (UL file # E89328).

Cables are available in unconnected or connected options. Refer to the Ordering Guide for part number information.

### HFBR-RXYYYY Series (POF) HFBR-EXXYYYY Series (POF)

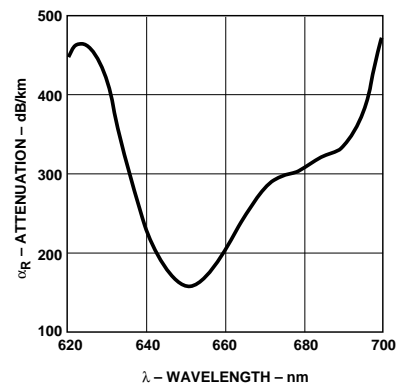

Figure 1. Typical POF Attenuation vs. Wavelength.

## Plastic Optical Fiber Specifications: HFBR-R/EXXYYY

### Absolute Maximum Ratings

Parameter		Symbol	Min.	Max.	Unit	Note
Storage and Operating Temperature		$T_{S,O}$	-55	+85	°C	
Recommended Operating Temperature		$T_O$	-40	+85	°C	
Installation Temperature		$T_I$	-20	+70	°C	1
Short Term Tensile Force	Single Channel	$F_T$		50	N	2
	Dual Channel	$F_T$		100	N	
Short Term Bend Radius		$r$	25		mm	3, 4
Long Term Bend Radius		$r$	35		mm	
Long Term Tensile Load		$F_T$		1	N	
Flexing				1000	Cycles	4

### Mechanical/Optical Characteristics, $T_A = -40$ to $+85^\circ\text{C}$ unless otherwise specified.

Parameter		Symbol	Min.	Typ. <sup>[5]</sup>	Max.	Unit	Condition
Cable Attenuation	Standard Cable, Type "R"	$\alpha_O$	0.15	0.22	0.27	dB/m	Source is HFBR-15XX (660 nm LED, 0.5 NA) $\ell = 50$ meters
	Extra Low Loss, Type "E"		0.15	0.19	0.23		
Reference Attenuation	Standard Cable, Type "R"	$\alpha_R$	0.12	0.19	0.24	dB/m	Source is 650 nm, 0.5 NA monochrometer, $\ell = 50$ meters Note 7, Figure 1
	Extra Low Loss, Type "E"		0.12	0.16	0.19		
Numerical Aperture		NA	0.46	0.47	0.50		>2 meters
Diameter, Core and Cladding		$D_C$	0.94	1.00	1.06	mm	
Diameter, Jacket		$D_J$	2.13	2.20	2.27	mm	Simplex Cable
Propagation Delay Constant		$l/v$		5.0		ns/m	Note 6
Mass per Unit Length/Channel				5.3		g/m	Without Connectors
Cable Leakage Current		$I_L$		12		nA	50 kV, $\ell = 0.3$ meters
Refractive Index	Core	$n$		1.492			
	Cladding			1.417			

#### Notes:

1. Installation temperature is the range over which the cable can be bent and pulled without damage. Below  $-20^\circ\text{C}$  the cable becomes brittle and should not be subjected to mechanical stress.
2. Short Term Tensile Force is for less than 30 minutes.
3. Short Term Bend Radius is for less than 1 hour nonoperating.
4.  $90^\circ$  bend on 25 mm radius mandrel. Bend radius is the radius of the mandrel around which the cable is bent.
5. Typical data are at  $25^\circ\text{C}$ .
6. Propagation delay constant is the reciprocal of the group velocity for propagation delay of optical power. Group velocity is  $v=c/n$  where  $c$  is the velocity of light in free space ( $3 \times 10^8$  m/s) and  $n$  is the effective core index of refraction.
7. Note that  $\alpha_R$  rises at the rate of about  $0.0067$  dB/ $^\circ\text{C}$ , where the thermal rise refers to the LED temperature changes above  $25^\circ\text{C}$ . Please refer to Figure 1 which shows the typical plastic optical fiber attenuation versus wavelength at  $25^\circ\text{C}$ .

## Plastic Fiber Connector Styles

### Connector Description

Four connector styles are available for termination of plastic optical fiber: simplex, simplex latching, duplex and duplex latching. All connectors provide a snap-in action when mated to Versatile Link components. Simplex connectors are color coded to facilitate identification of transmitter and receiver connections. Duplex connectors are keyed so that proper orientation is ensured during insertion. If the POF cable/connector will be used at extreme operating temperatures or experience frequent and wide temperature cycling effects, the cable/connector attachment can be strengthened with an RTV adhesive (see Plastic Connectoring Instructions for more detail). The connectors are made of a flame retardant VALOX UL94 V-0 material (UL file # E121562).

### SIMPLEX CONNECTOR STYLES

#### HFBR-4501/4511 — Simplex



SIMPLEX CRIMP RING, HFBR-4525

The simplex connector provides a quick and stable connection for applications that require a component-to-connector retention force of 8 Newtons (1.8 lb.). These connectors are available in gray (HFBR-4501) or blue (HFBR-4511).

#### HFBR-4503/4513 — Simplex Latching

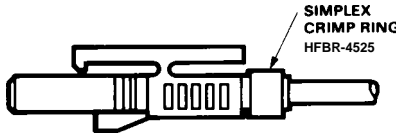

SIMPLEX CRIMP RING  
HFBR-4525

The simplex latching connector is designed for rugged applications requiring a greater retention force — 80 Newtons (18 lb.) — than provided by a simplex nonlatching connector. When inserting the simplex latching connector into a module, the connector latch mechanism should be aligned with the top surface of the horizontal modules, or with the tall vertical side of the vertical modules. Misalignment of an inserted latching connector into either module will not result in a positive latch. The connector is released by depressing the rear section of the connector lever, and then pulling the connector assembly away from the module housing.

The simplex latching connector is available in gray (HFBR-4503) or blue (HFBR-4513).

### DUPLEX CONNECTOR STYLES

#### HFBR-4506 — Duplex

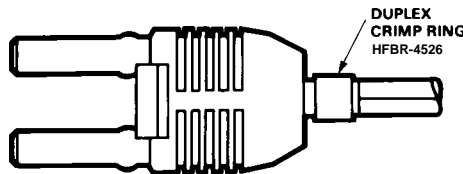

DUPLEX CRIMP RING  
HFBR-4526

Duplex connectors provide convenient duplex cable termination and are keyed to prevent incorrect insertion into duplex configured modules. The duplex connector is compatible with dual combinations of horizontal or vertical Versatile Link components (e.g., two horizontal transmitters, two vertical receivers, a horizontal transmitter with a horizontal receiver, etc.). The duplex non-

latching connector is available in parchment, off-white (HFBR-4506).

#### HFBR-4516 — Duplex Latching

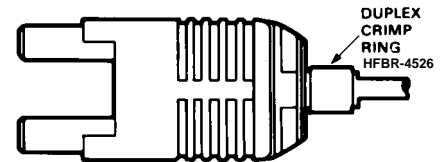
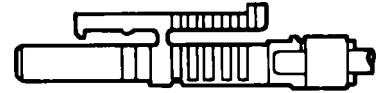

DUPLEX CRIMP RING  
HFBR-4526

The duplex latching connector is designed for rugged applications requiring greater retention force than the nonlatching duplex connector. When inserting the duplex latching connector into a module, the connector latch mechanism should be aligned with the top surface of the dual combination of horizontal or vertical Versatile Link components. The duplex latching connector is available in gray (HFBR-4516).

### Feedthrough/Splice

#### HFBR-4505/4515 Bulkhead Adapter

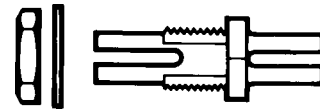

The HFBR-4505/4515 adapter mates two simplex connectors for panel/bulkhead feedthrough of HFBR-4501/4511 terminated plastic fiber cable. Maximum panel thickness is 4.1 mm (0.16 inch). This adapter can serve as a cable in-line splice using two simplex connectors. The adapters are available in gray (HFBR-4505) and blue (HFBR-4515). This adapter is not compatible with POF duplex, POF simplex latching, or HCS connectors.

## Plastic Optical Fiber Connector Absolute Maximum Ratings

Parameter	Symbol	Min.	Max.	Unit	Note
Storage and Operating Temperature	$T_{S,O}$	-40	85	°C	1
Recommended Operating Temperature	$T_O$	-40	85	°C	1
Installation Temperature	$T_I$	0	70	°C	1
Nut Torque HFBR-4505/4515 Adapter	$T_N$		0.7	N-m	2
			100	OzF-in.	

### Notes:

- Storage and Operating Temperatures refer to the ranges over which the connectors can be used when not subjected to mechanical stress. Installation Temperature refers to the ranges over which connectors may be installed onto the fiber and over which connectors can be connected and disconnected from transmitter and receiver modules.
- Recommended nut torque is 0.57 N-m.

## Plastic Optical Fiber Connector Mechanical/Optical Characteristics

$T_A = -40$  to  $+85^\circ\text{C}$ , Unless Otherwise Specified.

Parameter	Part Number	Symbol	Min.	Typ. <sup>[1]</sup>	Max.	Units	Temp. °C	Note
Retention Force, Connector to Versatile Link Transmitters and Receivers	Simplex, HFBR-4501/4511	$F_{R-C}$	7	8		N	+25	2
			3				-40 to +85	
	Simplex Latching, HFBR-4503/4513		47	80			+25	
			11				-40 to +85	
Duplex, HFBR-4506	Duplex Latching, HFBR-4516	7	12		+25			
		4			-40 to +85			
Tensile Force, Connector to Cable	Simplex, HFBR-4501/4511	$F_T$	8.5	22		N		3
			8.5	22				
	Duplex, HFBR-4506		14	35				
			14	35				
Adapter Connector to Connector Loss	HFBR-4505/4515 with HFBR-4501/4511	$\alpha_{CC}$	0.7	1.5	2.8	dB	25	4, 5
Retention Force Connector to Adapter	HFBR-4505/4515 with HFBR-4501/4511	$F_{R-B}$	7	8		N		
Insertion Force, Connector to Versatile Link Transmitters and Receivers	Simplex, HFBR-4501/4511	$F_I$		8	30	N		6
				16	35			
	Simplex Latching, HFBR-4503/4513			13	46			
			Duplex, HFBR-4506		22		51	
Duplex Latching HFBR-4516								

### Notes:

- Typical data are at  $+25^\circ\text{C}$ .
- No perceivable reduction in retention force was observed after 2000 insertions. Retention force of non-latching connectors is lower at elevated temperatures. Latching connectors are recommended for applications where a high retention force at high temperatures is desired.
- For applications where frequent temperature cycling over temperature extremes is expected, please contact Agilent Technologies for alternate connecting techniques.
- Minimum and maximum limit for  $\alpha_{CC}$  for  $0^\circ\text{C}$  to  $+70^\circ\text{C}$  temperature range. Typical value of  $\alpha_{CC}$  is at  $+25^\circ\text{C}$ .
- Factory polish or field polish per recommended procedure.
- Destructive insertion force was typically at 178 N (40 lb.).

## Step-by-Step Plastic Cable Connector Instructions

The following step-by-step guide describes how to terminate plastic fiber optic cable. It is ideal for both field and factory installation. Connectors can be easily installed on cable ends with wire strippers, cutters and a crimping tool.

Finishing the cable is accomplished with the Agilent HFBR-4593 Polishing Kit, consisting of a Polishing Fixture, 600 grit abrasive paper and 3  $\mu\text{m}$  pink lapping film (3M Company, OC3-14). The connector can be used immediately after polishing.

Materials needed for plastic fiber termination are:

1. Agilent Plastic Optical Fiber Cable (Example: HFBR-RUS500, HFBR-RUD500, HFBR-EUS500, or HFBR-EUD500)
2. Industrial Razor Blade or Wire Cutters
3. 16 Gauge Latching Wire Strippers (Example: Ideal Stripmaster™ type 45-092).
4. HFBR-4597 Crimping Tool
5. HFBR-4593 Polishing Kit
6. One of the following connectors:
  - a) HFBR-4501/4503 Gray Simplex/Simplex Latching Connector and HFBR-4525 Simplex Crimp Ring
  - b) HFBR-4511/4513 Blue Simplex/Simplex Latching Connector and HFBR-4525 Simplex Crimp Ring
  - c) HFBR-4506 Parchment (off-white) Duplex Connector and HFBR-4526 Duplex Crimp Ring
  - d) HFBR-4516 Gray Latching Duplex Connector and HFBR-4526 Duplex Crimp Ring

### Step 1

The zip cord structure of the duplex cable permits easy separation of the channels. The channels should be separated a minimum of 100 mm (4 in) to a maximum of 150 mm (6 in) back from the ends to permit connecting and polishing.

After cutting the cable to the desired length, strip off approximately 7 mm (0.3 in.) of the outer jacket with the 16 gauge wire strippers. Excess webbing on the duplex cable may have to be trimmed to allow the simplex or simplex latching connector to slide over the cable.

When using the duplex connector and duplex cable, the separated duplex cable must be stripped to equal lengths on each cable. This allows easy and proper seating of the cable into the duplex connector.

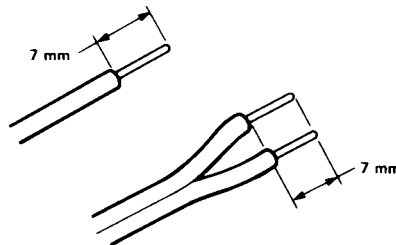

### Step 2

Place the crimp ring and connector over the end of the cable; the fiber should protrude about 3 mm (0.12 in.) through the end of the connector. Carefully position the ring so that it is entirely on the connector with the rim of the crimp ring flush with the connector, leaving a small space between the crimp ring and the flange. Then crimp the ring in place with the crimping tool. One crimp tool is used for all POF connector crimping requirements.

For applications with extreme temperature operation or frequent temperature cycling, improved connector to cable attachment can be achieved with the use of an RTV (GE Company, RTV-128 or Dow Corning 3145-RTV) adhesive. The RTV is placed into the connector prior to insertion of the fiber and the fiber is crimped normally. The connector can be polished after the RTV has cured and is then ready for use.

**Note:** By convention, place the gray connector on the transmitter cable end and the blue connector on the receiver cable end to maintain color coding (different color connectors are mechanically identical).

Simplex connector crimp rings cannot be used with duplex connectors and duplex connector crimp rings cannot be used with simplex connectors because of size differences. The simplex crimp has a dull luster appearance; the duplex ring is glossy and has a thinner wall.

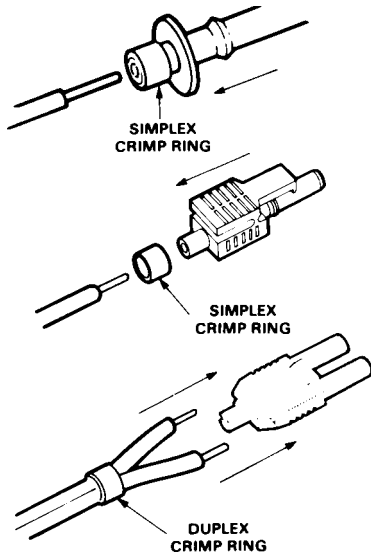

### Step 3

Any excess fiber protruding from the connector end may be cut off; however, the trimmed fiber should extend at least 1.5 mm (0.06 in) from the connector end.

Insert the connector fully into the polishing fixture with the trimmed fiber protruding from the bottom of the fixture. This plastic polishing fixture can be used to polish two simplex connectors or simplex latching connectors simultaneously, or one duplex connector.

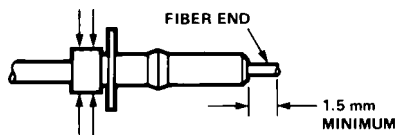

**Note:** The four dots on the bottom of the polishing fixture are wear indicators. Replace the polishing fixture when any

dot is no longer visible. Typically, the polishing fixture can be used 10 times; 10 duplex connectors or 20 simplex connectors, two at a time.

Place the 600 grit abrasive paper on a flat smooth surface, pressing down on the connector, polish the fiber and the connector using a figure eight pattern of strokes until the connector is flush with the bottom of the polishing fixture. Wipe the connector and fixture with a clean cloth or tissue.

### Step 4

Place the flush connector and polishing fixture on the dull side of the 3  $\mu$ m pink lapping film and continue to polish the fiber and connector for approximately 25 strokes. The fiber end should be flat, smooth and clean.

This cable is now ready for use.

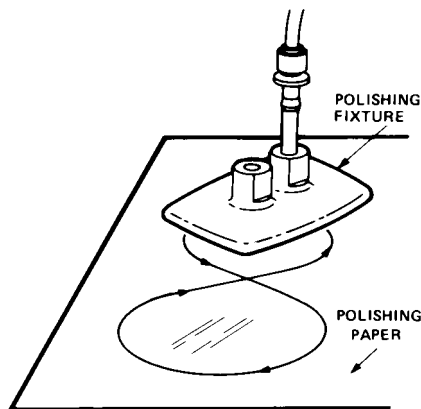

**Note:** Use of the pink lapping film fine polishing step results in approximately 2 dB improvement in coupling performance of either a transmitter-receiver link or a bulkhead/splice over a 600 grit polish alone. This fine polish is comparable to the Agilent factory polish. The fine polishing step may be omitted where an extra 2 dB of optical power is not essential, as with short link lengths. Proper polishing of the tip of the fiber/connector face results in a tip diameter between 2.5 mm (0.098 in.) minimum and 3.2 mm (0.126 in.) maximum..

### HFBR-4593 Polishing Kit

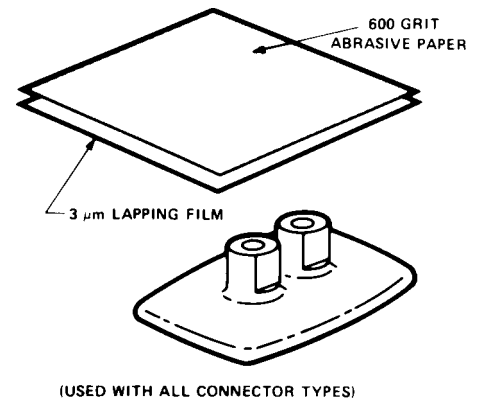

## Ordering Guide for POF Connectors and Accessories

### Plastic Optical Fiber Connectors

HFBR-4501	Gray Simplex Connector/Crimp Ring
HFBR-4511	Blue Simplex Connector/Crimp Ring
HFBR-4503	Gray Simplex Latching Connector with Crimp Ring
HFBR-4513	Blue Simplex Latching Connector with Crimp Ring
HFBR-4506	Parchment Duplex Connector with Crimp Ring
HFBR-4516	Gray Duplex Latching Connector with Crimp Ring
HFBR-4505	Gray Adapter (Bulkhead/Feedthrough)
HFBR-4515	Blue Adapter (Bulkhead/Feedthrough)

### Plastic Optical Fiber Accessories

HFBR-4522	500 HFBR-0500 Products Port Plugs
HFBR-4525	1000 Simplex Crimp Rings
HFBR-4526	500 Duplex Crimp Rings
HFBR-4593	Polishing Kit (one polishing tool, two pieces 600 grit abrasive paper, and two pieces 3 $\mu$ m pink lapping film)
HFBR-4597	Plastic Fiber Crimping Tool

## Ordering Guide for POF Cable

### For Example:

HFBR-RUD500 is a Standard Attenuation, Unconnected, Duplex, 500 meter cable.

HFBR-RLS001 is a Standard Attenuation, Latching Simplex Connected, Simplex, 1 meter cable.

HFBR-RMD010 is a Standard Attenuation, Standard Duplex Connected, Duplex, 10 meter cable.

HFBR-RMD100 is a Standard Attenuation, Standard Duplex Connected, Duplex, 100 meter cable.

### Cable Length Tolerances:

The plastic cable length tolerances are: +10%/-0%.

**NOTE:** By convention, pre-connected simplex POF cables have gray and blue colored connectors on the opposite ends of the same fiber; although oppositely colored, the connectors are mechanically identical. Duplex POF cables with duplex connectors use color-coded markings on the duplex fiber cable to differentiate between the channel.

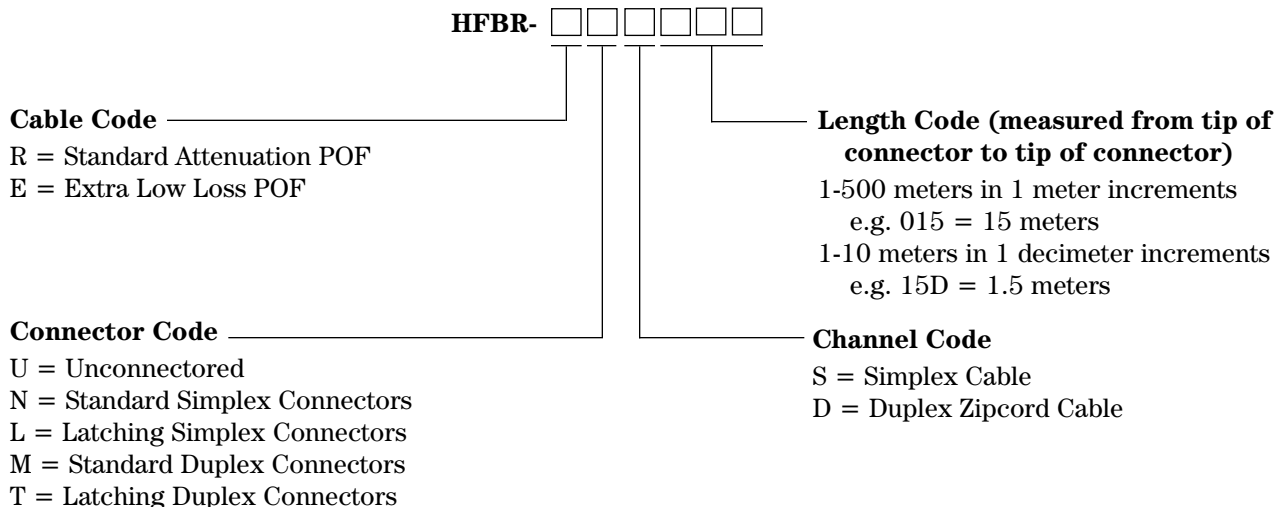

**Note:** Not all possible combinations reflect available part numbers. Please contact your local Agilent representative for a list of current available cable part numbers.

# Connector Applications

## Attachment to Agilent Versatile Link Fiber Optic Components

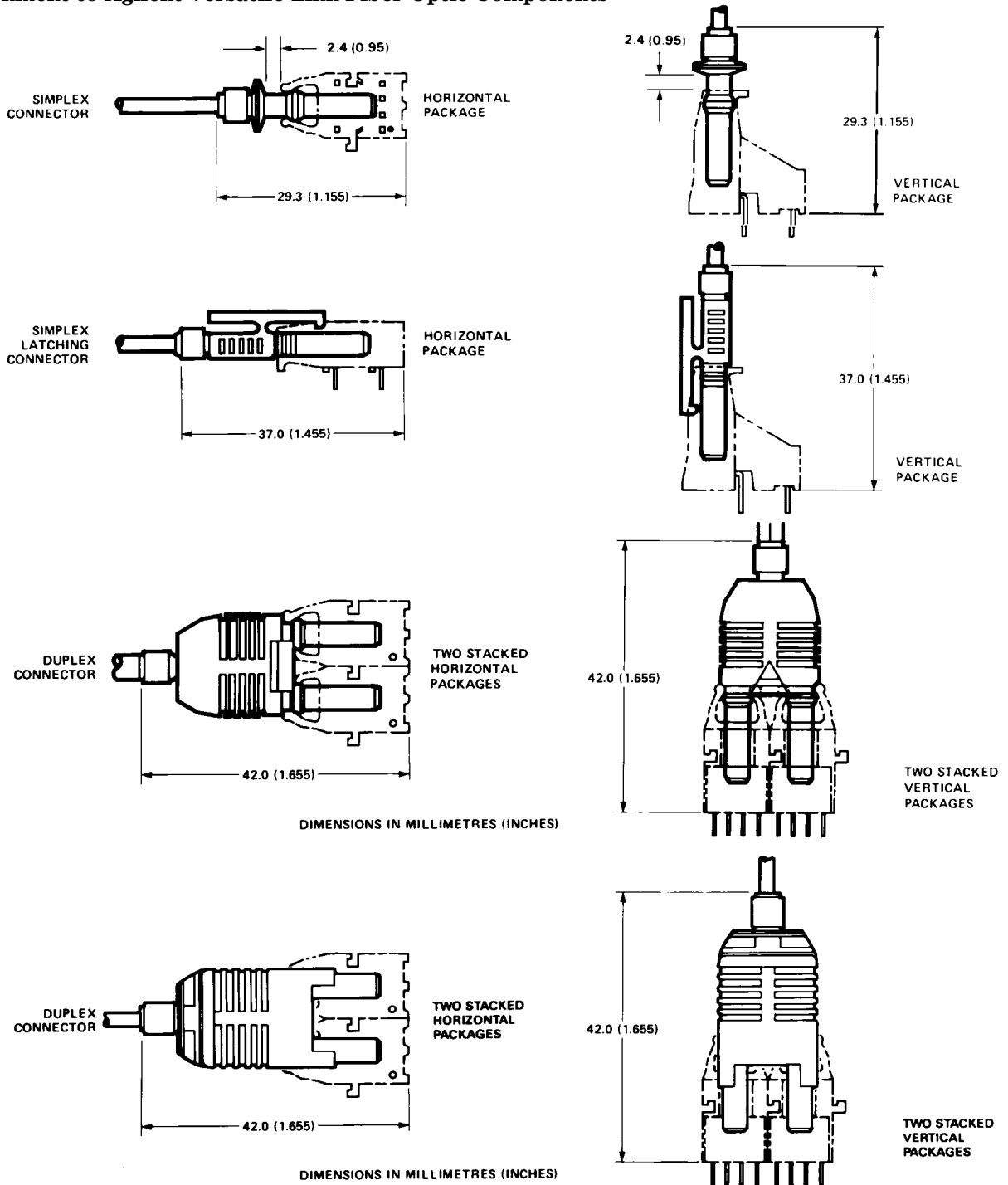

## Bulkhead Feedthrough or Panel Mounting for HFBR-4501/4511 Simplex Connectors

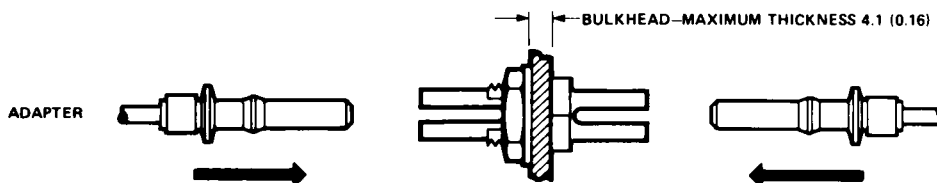



## Versatile Link Mechanical Dimensions

All dimensions in mm (inches).

All dimensions  $\pm 0.25$  mm unless otherwise specified.

### Fiber Optic Cable Dimensions

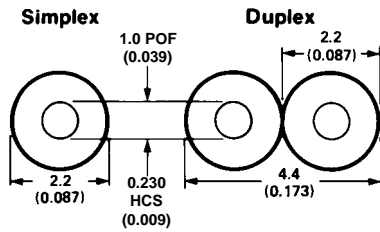

### Panel Mounting – Bulkhead Feedthrough

THREE TYPES OF PANEL/BULKHEAD HOLES CAN BE USED.

DIMENSIONS IN mm (INCHES)  
 ALL DIMENSIONS  $\pm 0.2$  mm

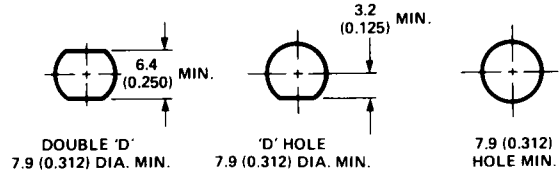

### HFBR-4505 (Gray)/4515 (Blue) Adapters

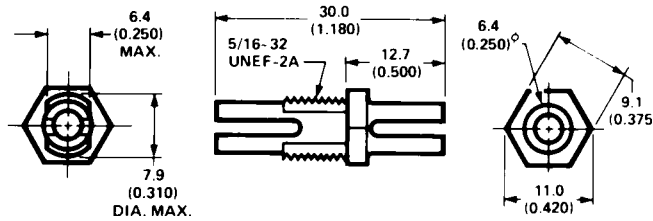

### Bulkhead Feedthrough with Two HFBR-4501/4511 Connectors

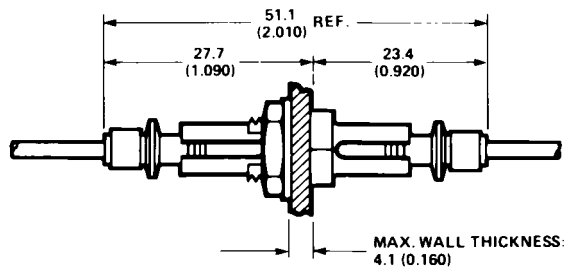



**[www.agilent.com/semiconductors](http://www.agilent.com/semiconductors)**

For product information and a complete list of distributors, please go to our web site.

For technical assistance call:

Americas/Canada: +1 (800) 235-0312 or  
(408) 654-8675

Europe: +49 (0) 6441 92460

China: 10800 650 0017

Hong Kong: (+65) 6271 2451

India, Australia, New Zealand: (+65) 6271 2394

Japan: (+81 3) 3335-8152(Domestic/International), or 0120-61-1280(Domestic Only)

Korea: (+65) 6271 2194

Malaysia, Singapore: (+65) 6271 2054

Taiwan: (+65) 6271 2654

Data subject to change.

Copyright © 2002 Agilent Technologies, Inc.

Obsoletes 5963-3711E

April 6, 2002

5988-3625EN

This datasheet has been download from:

[www.datasheetcatalog.com](http://www.datasheetcatalog.com)

Datasheets for electronics components.