

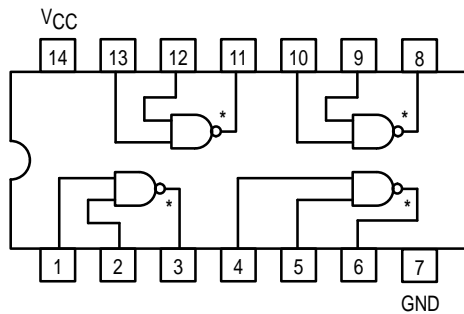

QUAD 2-INPUT NAND GATE

- ESD > 3500 Volts



*OPEN COLLECTOR OUTPUTS

SN54/74LS03

QUAD 2-INPUT NAND GATE
LOW POWER SCHOTTKY

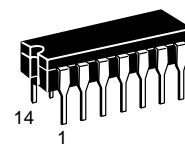

J SUFFIX
CERAMIC
CASE 632-08

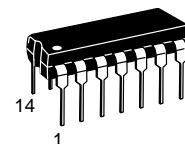

N SUFFIX
PLASTIC
CASE 646-06

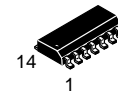

D SUFFIX
SOIC
CASE 751A-02

ORDERING INFORMATION

SN54LSXXJ	Ceramic
SN74LSXXN	Plastic
SN74LSXXD	SOIC

GUARANTEED OPERATING RANGES

Symbol	Parameter		Min	Typ	Max	Unit
V _{CC}	Supply Voltage	54	4.5	5.0	5.5	V
		74	4.75	5.0	5.25	
T _A	Operating Ambient Temperature Range	54	-55	25	125	°C
		74	0	25	70	
V _{OH}	Output Voltage — High	54, 74			5.5	V
I _{OL}	Output Current — Low	54			4.0	mA
		74			8.0	

SN54/74LS03

DC CHARACTERISTICS OVER OPERATING TEMPERATURE RANGE (unless otherwise specified)

Symbol	Parameter		Limits			Unit	Test Conditions	
			Min	Typ	Max			
V_{IH}	Input HIGH Voltage		2.0			V	Guaranteed Input HIGH Voltage for All Inputs	
V_{IL}	Input LOW Voltage	54			0.7	V	Guaranteed Input LOW Voltage for All Inputs	
		74			0.8			
V_{IK}	Input Clamp Diode Voltage			-0.65	-1.5	V	$V_{CC} = \text{MIN}$, $I_{IN} = -18 \text{ mA}$	
I_{OH}	Output HIGH Current	54, 74			100	μA	$V_{CC} = \text{MIN}$, $V_{OH} = \text{MAX}$	
V_{OL}	Output LOW Voltage	54, 74		0.25	0.4	V	$I_{OL} = 4.0 \text{ mA}$	$V_{CC} = V_{CC} \text{ MIN}$, $V_{IN} = V_{IL} \text{ or } V_{IH}$ per Truth Table
		74		0.35	0.5	V	$I_{OL} = 8.0 \text{ mA}$	
I_{IH}	Input HIGH Current				20	μA	$V_{CC} = \text{MAX}$, $V_{IN} = 2.7 \text{ V}$	
					0.1	mA	$V_{CC} = \text{MAX}$, $V_{IN} = 7.0 \text{ V}$	
I_{IL}	Input LOW Current				-0.4	mA	$V_{CC} = \text{MAX}$, $V_{IN} = 0.4 \text{ V}$	
I_{CC}	Power Supply Current Total, Output HIGH				1.6	mA	$V_{CC} = \text{MAX}$	
	Total, Output LOW				4.4			

AC CHARACTERISTICS ($T_A = 25^\circ\text{C}$)

Symbol	Parameter		Limits			Unit	Test Conditions	
			Min	Typ	Max			
t_{PLH}	Turn-Off Delay, Input to Output			17	32	ns	$V_{CC} = 5.0 \text{ V}$ $C_L = 15 \text{ pF}$, $R_L = 2.0 \text{ k}\Omega$	
t_{PHL}	Turn-On Delay, Input to Output			15	28	ns		